

Ultra-Fast-Recovery Rectifier Diodes **600V**

$t_{rr} \textcircled{1}$: $I_F/I_R (=I_F)$ 90% Recovery Point
 (ex. $I_F/I_R = 100\text{mA}/100\text{mA}$ 90% Recovery Point)
 $t_{rr} \textcircled{2}$: $I_F/I_R (=2 I_F)$ 75% Recovery Point
 (ex. $I_F/I_R = 100\text{mA}/200\text{mA}$ 75% Recovery Point)

V_{RM} (V)	Package	Part Number	I_F (AV) (A)	I_{FSM} (A)	T_j (°C)	T_{stg} (°C)	V_F (V) max	I_F (A)	I_R (μ A)	I_R (H) (mA)	T_a (°C)	$t_{rr} \textcircled{1}$ (ns)		$t_{rr} \textcircled{2}$ (ns)		$R_{th(j-\ell)}$ $R_{th(j-c)}$ (°C/W)	Mass (g)	Fig. No.	Page where characteristic curve is shown
				50Hz Half-cycle Sinewave Single Shot					$V_R = V_{RM}$ max	$V_R = V_{RM}$ max		I_F/I_{FP} (mA)	I_F/I_{FP} (mA)						
600	Surface Mount	MP3-306	30.0	180	-40 to +150	1.7	30.0	100	0.5	150 (Tj)	150	500/500	70	500/1000	2.0	1.04	13	80	
	Axial	AG01A	0.5	15	-40 to +150	1.8	0.5	100	0.5	100	100	100/100	50	100/200	22	0.13	1	64	
		EG01A	0.5	10	-40 to +150	2.0	0.5	100	0.5	100	100	100/100	50	100/200	20	0.2	2	65	
		EG 1A	0.6	10	-40 to +150	2.0	0.6	100	0.5	100	100	100/100	50	100/200	17	0.3	3	66	
		RG 10A	1.0	50	-40 to +150	2.0	1.0	500	2.5	100	100	100/100	50	100/200	15	0.4	4		
		RG 2A	1.0	50	-40 to +150	2.0	1.0	500	2.5	100	100	100/100	50	100/200	12	0.6	5	68	
		RD 2A	1.2	30	-40 to +150	1.55	1.2	50	0.1	150	50	100/100	35	100/200	12	0.6	6	69	
		RL 3A	2.0	60	-40 to +150	1.7	3.0	50	0.2	150 (Tj)	50	100/100	35	100/200	10	1.0	6	70	
		RG 4A	1.0 (2.0)	50	-40 to +150	2.0	2.0	500	2.5	100	100	100/100	50	100/200	8	1.2	7		
		RL 4A	3.0	80	-40 to +150	1.5	3.0	50	0.1	150 (Tj)	50	500/500	35	500/1000	8	1.2	7	71	
	Frame-2Pin	FMG-G26S	4.0	50	-40 to +150	2.5	4.0	500	3.0	100	100	100/100	50	100/200	4.0	2.1	8	72	
		FML-G16S	5.0	50	-40 to +150	1.5	5.0	100	0.5	100	50	500/500	35	500/1000	4.0	2.1		79	
		FMX-G16S	5.0	50	-40 to +150	1.5	5.0	50	15	150	30	500/500	25	500/1000	4.0	2.1			
		FMN-G16S*	5.0	50	-40 to +150	1.2	5.0	50	10	150 (Tj)	100	100/100	50	100/200	4.0	2.1		—	
		FMD-G26S	10.0	100	-40 to +150	1.7	10.0	100	0.3	150	50	500/500	30	500/1000	4.0	2.1		80	
		FMX-G26S	10.0	100	-40 to +150	1.5	10.0	100	20	150	30	500/500	25	500/1000	4.0	2.1			
		FMG-G36S	8.0	80	-40 to +150	2.5	8.0	500	3	100	100	500/500	50	500/1000	2.0	5.5		9	74
	Center-tap	FMC-26U	3.0	50	-40 to +150	2.0	3.0	500	3	150 (Tj)	70	500/500	35	500/1000	4.0	2.1	10	74	
		FMG-26S, R	6.0	50	-40 to +150	2.2	3.0	500	3	100	100	100/100	50	100/200	4.0	2.1	11	75	
		FMG-36S, R	15.0	80	-40 to +150	2.2	7.5	1000	5	100	100	100/100	50	100/200	2.0	5.5	12	78	
		FML-36S	20.0	100	-40 to +150	1.7	10.0	100	0.3	100	65	500/500	35	500/1000	2.0	5.5			

* : Under development

Ultra-Fast-Recovery Rectifier Diodes 600V

External Dimensions Flammability: UL94V-0 or Equivalent (Unit: mm)

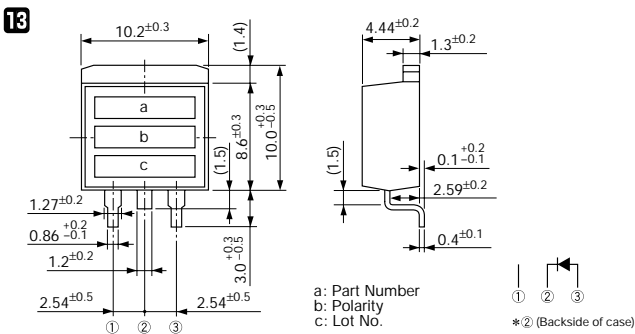
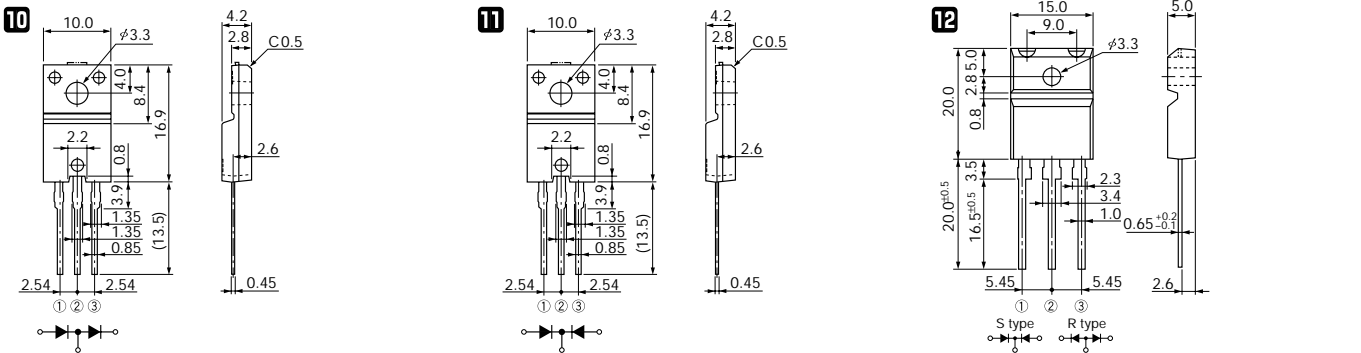
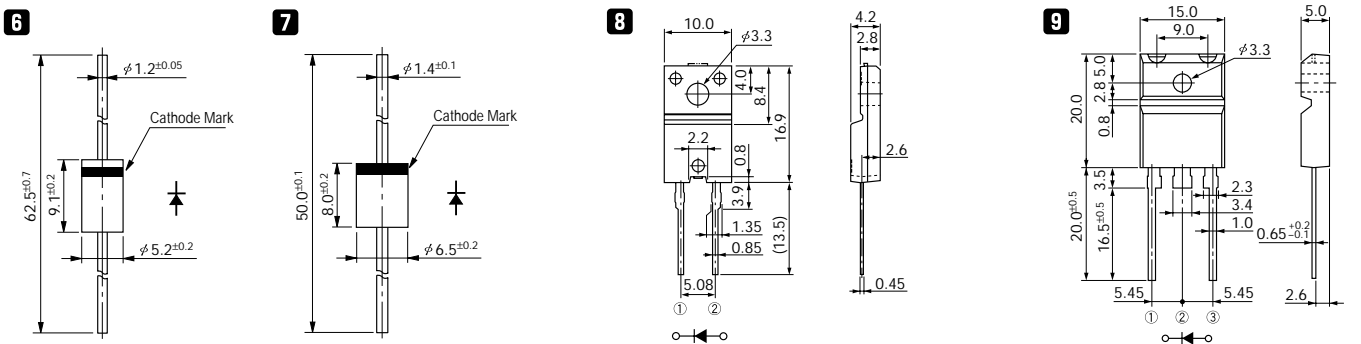
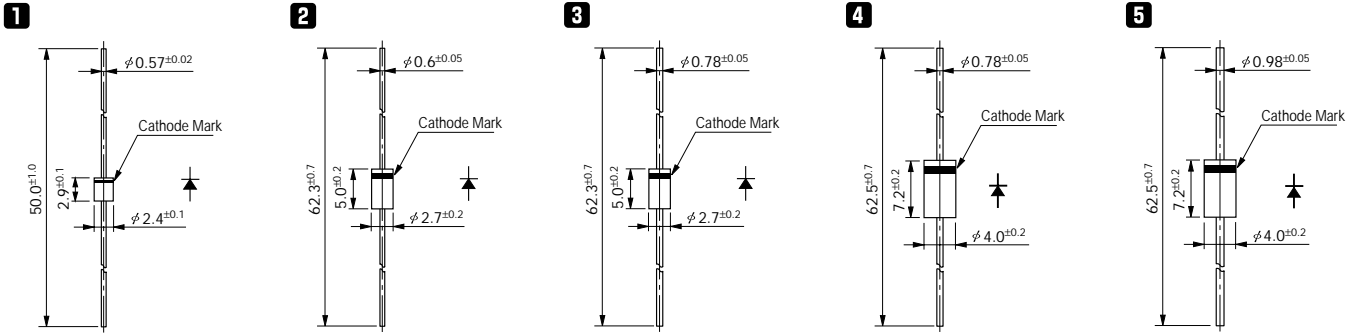

Ultra-Fast-Recovery Rectifier Diodes

FMG-36S/R

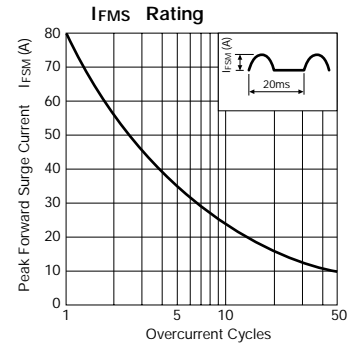
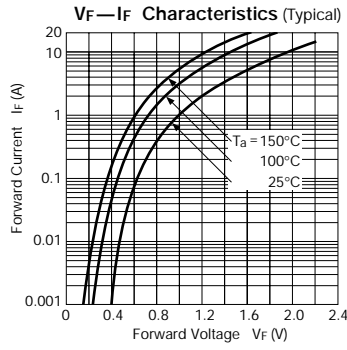
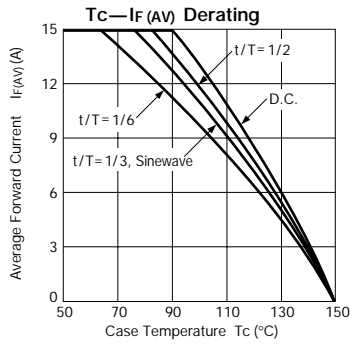

FML-32S

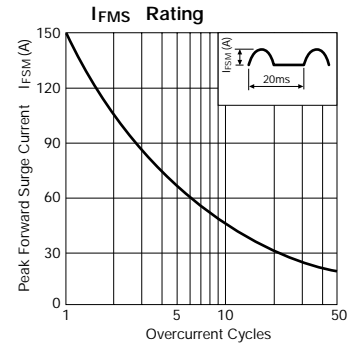
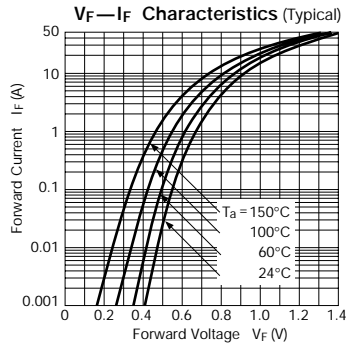
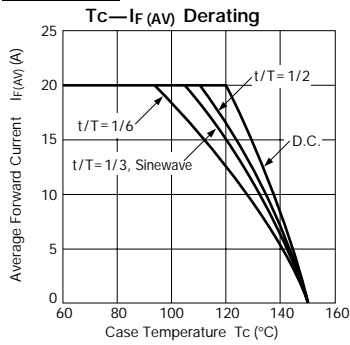

FML-33S, 34S

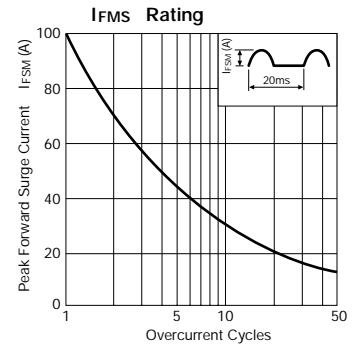
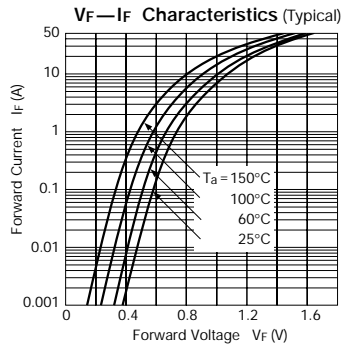
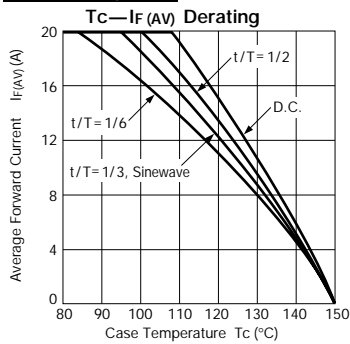

FML-36S

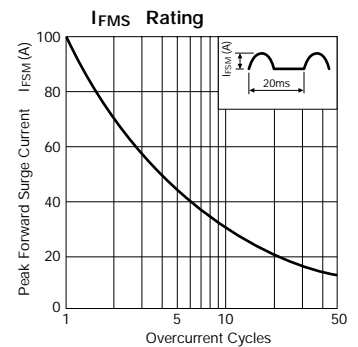
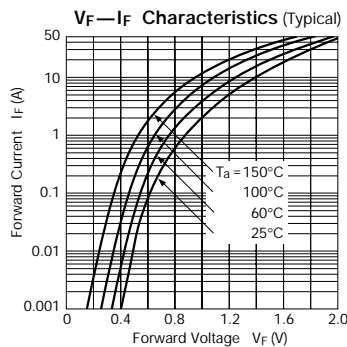
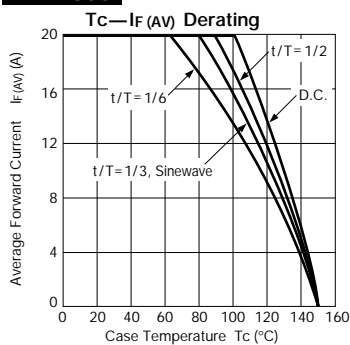

FMX-32S

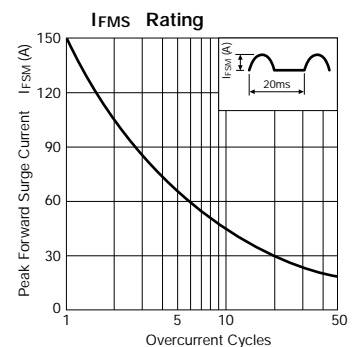
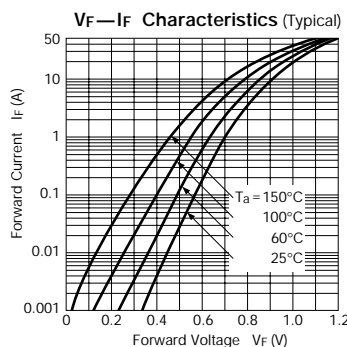
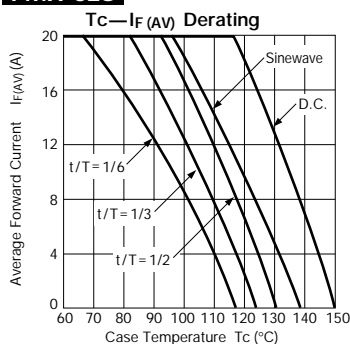

This datasheet has been download from:

www.datasheetcatalog.com

Datasheets for electronics components.