

LM337L 3-Terminal Adjustable Regulator

Check for Samples: [LM337L](#)

FEATURES

- Adjustable Output Down to 1.2V
- Ensured 100mA Output Current
- Line Regulation Typically 0.01%/V
- Load Regulation Typically 0.1%
- Current Limit Constant With Temperature
- Eliminates the Need to Stock Many Voltages
- Standard 3-Lead Transistor Package
- 80 dB Ripple Rejection
- Output is Short Circuit Protected
- Available in the 6-Bump DSBGA Package
- See AN-1112 (Literature Number [SNVA009](#)) for DSBGA Considerations

DESCRIPTION

The LM337L is an adjustable 3-terminal negative voltage regulator capable of supplying 100mA over a 1.2V to 37V output range. It is exceptionally easy to use and requires only two external resistors to set the output voltage. Furthermore, both line and load regulation are better than standard fixed regulators. Also, the LM337L is packaged in a standard TO-92 transistor package which is easy to use.

In addition to higher performance than fixed regulators, the LM337L offers full overload protection. Included on the chip are current limit, thermal overload protection and safe area protection. All overload protection circuitry remains fully functional even if the adjustment terminal is disconnected.

Normally, only a single 1 μ F solid tantalum output capacitor is needed unless the device is situated more than 6 inches from the input filter capacitors, in which case an input bypass is needed. A larger output capacitor can be added to improve transient response. The adjustment terminal can be bypassed to achieve very high ripple rejection ratios which are difficult to achieve with standard 3-terminal regulators.

Besides replacing fixed regulators, the LM337L is useful in a wide variety of other applications. Since the regulator is “floating” and sees only the input-to-output differential voltage, supplies of several hundred volts can be regulated as long as the maximum input-to-output differential is not exceeded.

Also, it makes an especially simple adjustable switching regulator, a programmable output regulator, or by connecting a fixed resistor between the adjustment and output, the LM337L can be used as a precision current regulator. Supplies with electronic shutdown can be achieved by clamping the adjustment terminal to ground which programs the output to 1.2V where most loads draw little current.

The LM337L is available in a standard TO-92 transistor package, SO-8 surface mount package, and in our new 12 mil diameter bump DSBGA package. The LM337L is rated for operation over a -25°C to $+125^{\circ}\text{C}$ range.

For applications requiring greater output current in excess of 0.5A and 1.5A, see LM137 series data sheets. For the positive complement, see series LM117 and LM317L data sheets.

Typical Application

1.2V-25V Adjustable Regulator

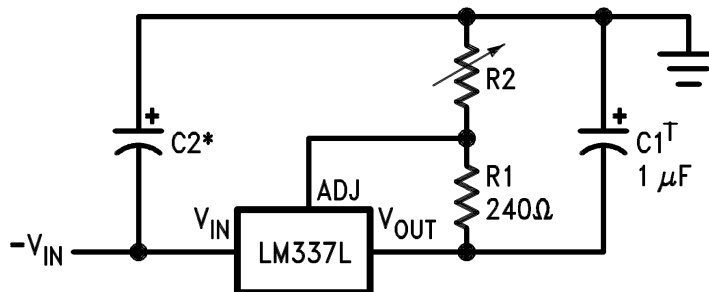

Please be aware that an important notice concerning availability, standard warranty, and use in critical applications of Texas Instruments semiconductor products and disclaimers thereto appears at the end of this data sheet.

All trademarks are the property of their respective owners.

Connection Diagrams

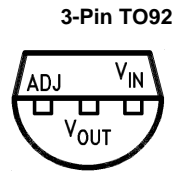

Figure 1. Bottom View

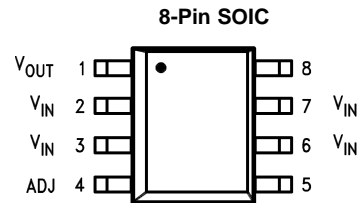
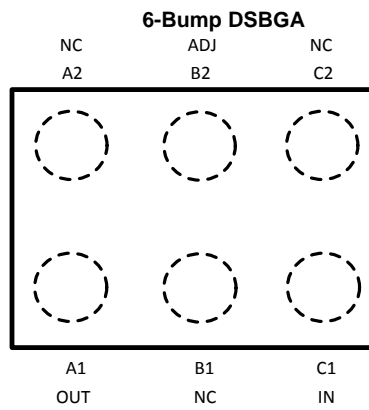

Figure 2. Top View





These devices have limited built-in ESD protection. The leads should be shorted together or the device placed in conductive foam during storage or handling to prevent electrostatic damage to the MOS gates.

Absolute Maximum Ratings⁽¹⁾⁽²⁾

Power Dissipation	Internally Limited
Input–Output Voltage Differential	40V
Operating Junction Temperature Range	–25°C to +125°C
Storage Temperature	–55°C to +150°C
Lead Temperature (Soldering, 10 sec.)	300°C
Plastic Package (Soldering 4 sec.)	260°C
ESD Rating	1.5kV ⁽³⁾

- (1) “Absolute Maximum Ratings” indicate limits beyond which damage to the device may occur. Operating Ratings indicate conditions for which the device is functional, but do not ensure specific performance limits.
- (2) If Military/Aerospace specified devices are required, please contact the Texas Instruments Sales Office/Distributors for availability and specifications.
- (3) Human body model, 1.5kΩ in series with 100pF.

Electrical Characteristics⁽¹⁾

Parameter	Conditions	Min	Typ	Max	Units
Line Regulation	$T_A = 25^\circ\text{C}$, $3\text{V} \leq V_{\text{IN}} - V_{\text{OUT}} \leq 40\text{V}^{(2)}$		0.01	0.04	%/V
Load Regulation	$T_A = 25^\circ\text{C}$, $5\text{mA} \leq I_{\text{OUT}} \leq I_{\text{MAX}}^{(2)}$		0.1	0.5	%
Thermal Regulation	$T_A = 25^\circ\text{C}$, 10ms Pulse		0.04	0.2	%/W
Adjustment Pin Current			50	100	μA
Adjustment Pin Current Change	$5\text{mA} \leq I_L \leq 100\text{mA}$ $3\text{V} \leq V_{\text{IN}} - V_{\text{OUT}} \leq 40\text{V}$		0.2	5	μA
Reference Voltage	$3\text{V} \leq V_{\text{IN}} - V_{\text{OUT}} \leq 40\text{V}^{(3)}$ $10\text{mA} \leq I_{\text{OUT}} \leq 100\text{mA}$, $P \leq 625\text{mW}$	1.20	1.25	1.30	V
Line Regulation	$3\text{V} \leq V_{\text{IN}} - V_{\text{OUT}} \leq 40\text{V}^{(2)}$		0.02	0.07	%/V
Load Regulation	$5\text{mA} \leq I_{\text{OUT}} \leq 100\text{mA}^{(2)}$		0.3	1.5	%
Temperature Stability	$T_{\text{MIN}} \leq T_j \leq T_{\text{MAX}}$		0.65		%
Minimum Load Current	$ V_{\text{IN}} - V_{\text{OUT}} \leq 40\text{V}$		3.5	5	mA
	$3\text{V} \leq V_{\text{IN}} - V_{\text{OUT}} \leq 15\text{V}$		2.2	3.5	mA
Current Limit	$3\text{V} \leq V_{\text{IN}} - V_{\text{OUT}} \leq 13\text{V}$	100	200	320	mA
	$ V_{\text{IN}} - V_{\text{OUT}} = 40\text{V}$	25	50	120	mA
Rms Output Noise, % of V_{OUT}	$T_A = 25^\circ\text{C}$, $10\text{Hz} \leq f \leq 10\text{kHz}$		0.003		%
Ripple Rejection Ratio	$V_{\text{OUT}} = -10\text{V}$, $F = 120\text{Hz}$, $C_{\text{ADJ}} = 0$		65		dB
	$C_{\text{ADJ}} = 10\mu\text{F}$	66	80		dB
Long-Term Stability	$T_A = 125^\circ\text{C}$		0.3	1	%

- (1) Unless otherwise specified, these specifications apply $-25^\circ\text{C} \leq T_j \leq +125^\circ\text{C}$ for the LM337L; $|V_{\text{IN}} - V_{\text{OUT}}| = 5\text{V}$ and $I_{\text{OUT}} = 40\text{mA}$. Although power dissipation is internally limited, these specifications are applicable for power dissipations up to 625 mW. I_{MAX} is 100mA.
- (2) Regulation is measured at constant junction temperature, using pulse testing with a low duty cycle. Changes in output voltage due to heating effects are covered under the specification for thermal regulation.
- (3) Thermal resistance of the TO-92 package is $180^\circ\text{C}/\text{W}$ junction to ambient with 0.4" leads from a PC board and $160^\circ\text{C}/\text{W}$ junction to ambient with 0.125" lead length to PC board. The SOIC package θ_{JA} is $180^\circ\text{C}/\text{W}$ in still air. The 6-Bump DSBGA package θ_{JA} is $290^\circ\text{C}/\text{W}$ in still air.

Typical Applications

1.2V-25V Adjustable Regulator

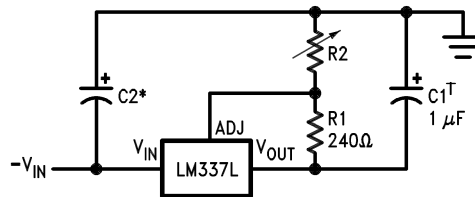

Full output current not available at high input-output voltages

$$-V_{OUT} = -1.25V \left(1 + \frac{R2}{240\Omega} \right)$$

†C1 = 1μF solid tantalum or 10μF aluminum electrolytic required for stability

*C2 = 1μF solid tantalum is required only if regulator is more than 4" from power supply filter capacitor

Regulator with Trimmable Output Voltage

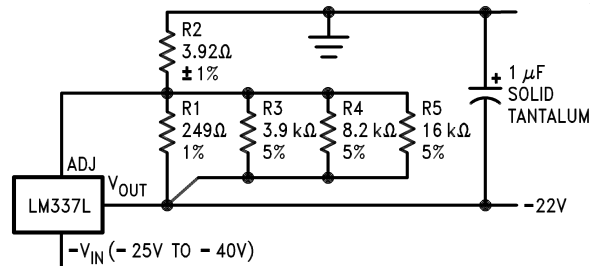

Trim Procedure:

—If V_{OUT} is $-23.08V$ or bigger, cut out R3 (if smaller, don't cut it out).

—Then if V_{OUT} is $-22.47V$ or bigger, cut out R4 (if smaller, don't).

—Then if V_{OUT} is $-22.16V$ or bigger, cut out R5 (if smaller, don't).

This will trim the output to well within 1% of $-22.00 V_{DC}$, without any of the expense or trouble of a trim pot (see LB-46). Of course, this technique can be used at any output voltage level.

REVISION HISTORY

Changes from Revision C (May 2013) to Revision D	Page
<hr/> <ul style="list-style-type: none">• Changed layout of National Data Sheet to TI format	<hr/> 4

PACKAGING INFORMATION

Orderable Device	Status (1)	Package Type	Package Drawing	Pins	Package Qty	Eco Plan (2)	Lead/Ball Finish (6)	MSL Peak Temp (3)	Op Temp (°C)	Device Marking (4/5)	Samples
LM337LM	NRND	SOIC	D	8	95	TBD	Call TI	Call TI	-25 to 100	LM337 LM	
LM337LM/NOPB	ACTIVE	SOIC	D	8	95	Green (RoHS & no Sb/Br)	CU SN	Level-1-260C-UNLIM	-25 to 100	LM337 LM	Samples
LM337LMX	NRND	SOIC	D	8	2500	TBD	Call TI	Call TI	-25 to 100	LM337 LM	
LM337LMX/NOPB	ACTIVE	SOIC	D	8	2500	Green (RoHS & no Sb/Br)	CU SN	Level-1-260C-UNLIM	-25 to 100	LM337 LM	Samples
LM337LZ/LFT1	ACTIVE	TO-92	LP	3	2000	Green (RoHS & no Sb/Br)	CU SN	N / A for Pkg Type		LM337 LZ	Samples
LM337LZ/LFT3	ACTIVE	TO-92	LP	3	2000	Green (RoHS & no Sb/Br)	CU SN	N / A for Pkg Type		LM337 LZ	Samples
LM337LZ/LFT4	ACTIVE	TO-92	LP	3	2000	Green (RoHS & no Sb/Br)	CU SN	N / A for Pkg Type		LM337 LZ	Samples
LM337LZ/NOPB	ACTIVE	TO-92	LP	3	1800	Green (RoHS & no Sb/Br)	CU SN	N / A for Pkg Type	-25 to 100	LM337 LZ	Samples

(1) The marketing status values are defined as follows:

ACTIVE: Product device recommended for new designs.

LIFEBUY: TI has announced that the device will be discontinued, and a lifetime-buy period is in effect.

NRND: Not recommended for new designs. Device is in production to support existing customers, but TI does not recommend using this part in a new design.

PREVIEW: Device has been announced but is not in production. Samples may or may not be available.

OBSOLETE: TI has discontinued the production of the device.

(2) Eco Plan - The planned eco-friendly classification: Pb-Free (RoHS), Pb-Free (RoHS Exempt), or Green (RoHS & no Sb/Br) - please check <http://www.ti.com/productcontent> for the latest availability information and additional product content details.

TBD: The Pb-Free/Green conversion plan has not been defined.

Pb-Free (RoHS): TI's terms "Lead-Free" or "Pb-Free" mean semiconductor products that are compatible with the current RoHS requirements for all 6 substances, including the requirement that lead not exceed 0.1% by weight in homogeneous materials. Where designed to be soldered at high temperatures, TI Pb-Free products are suitable for use in specified lead-free processes.

Pb-Free (RoHS Exempt): This component has a RoHS exemption for either 1) lead-based flip-chip solder bumps used between the die and package, or 2) lead-based die adhesive used between the die and leadframe. The component is otherwise considered Pb-Free (RoHS compatible) as defined above.

Green (RoHS & no Sb/Br): TI defines "Green" to mean Pb-Free (RoHS compatible), and free of Bromine (Br) and Antimony (Sb) based flame retardants (Br or Sb do not exceed 0.1% by weight in homogeneous material)

(3) MSL, Peak Temp. - The Moisture Sensitivity Level rating according to the JEDEC industry standard classifications, and peak solder temperature.

(4) There may be additional marking, which relates to the logo, the lot trace code information, or the environmental category on the device.

(5) Multiple Device Markings will be inside parentheses. Only one Device Marking contained in parentheses and separated by a "~" will appear on a device. If a line is indented then it is a continuation of the previous line and the two combined represent the entire Device Marking for that device.

(6) Lead/Ball Finish - Orderable Devices may have multiple material finish options. Finish options are separated by a vertical ruled line. Lead/Ball Finish values may wrap to two lines if the finish value exceeds the maximum column width.

Important Information and Disclaimer:The information provided on this page represents TI's knowledge and belief as of the date that it is provided. TI bases its knowledge and belief on information provided by third parties, and makes no representation or warranty as to the accuracy of such information. Efforts are underway to better integrate information from third parties. TI has taken and continues to take reasonable steps to provide representative and accurate information but may not have conducted destructive testing or chemical analysis on incoming materials and chemicals. TI and TI suppliers consider certain information to be proprietary, and thus CAS numbers and other limited information may not be available for release.

In no event shall TI's liability arising out of such information exceed the total purchase price of the TI part(s) at issue in this document sold by TI to Customer on an annual basis.

TAPE AND REEL INFORMATION



QUADRANT ASSIGNMENTS FOR PIN 1 ORIENTATION IN TAPE



*All dimensions are nominal

Device	Package Type	Package Drawing	Pins	SPQ	Reel Diameter (mm)	Reel Width W1 (mm)	A0 (mm)	B0 (mm)	K0 (mm)	P1 (mm)	W (mm)	Pin1 Quadrant
LM337LMX	SOIC	D	8	2500	330.0	12.4	6.5	5.4	2.0	8.0	12.0	Q1
LM337LMX/NOPB	SOIC	D	8	2500	330.0	12.4	6.5	5.4	2.0	8.0	12.0	Q1

TAPE AND REEL BOX DIMENSIONS



*All dimensions are nominal

Device	Package Type	Package Drawing	Pins	SPQ	Length (mm)	Width (mm)	Height (mm)
LM337LMX	SOIC	D	8	2500	367.0	367.0	35.0
LM337LMX/NOPB	SOIC	D	8	2500	367.0	367.0	35.0

D (R-PDSO-G8)

PLASTIC SMALL OUTLINE





4040047-3/M 06/11

LP (O-PBCY-W3)

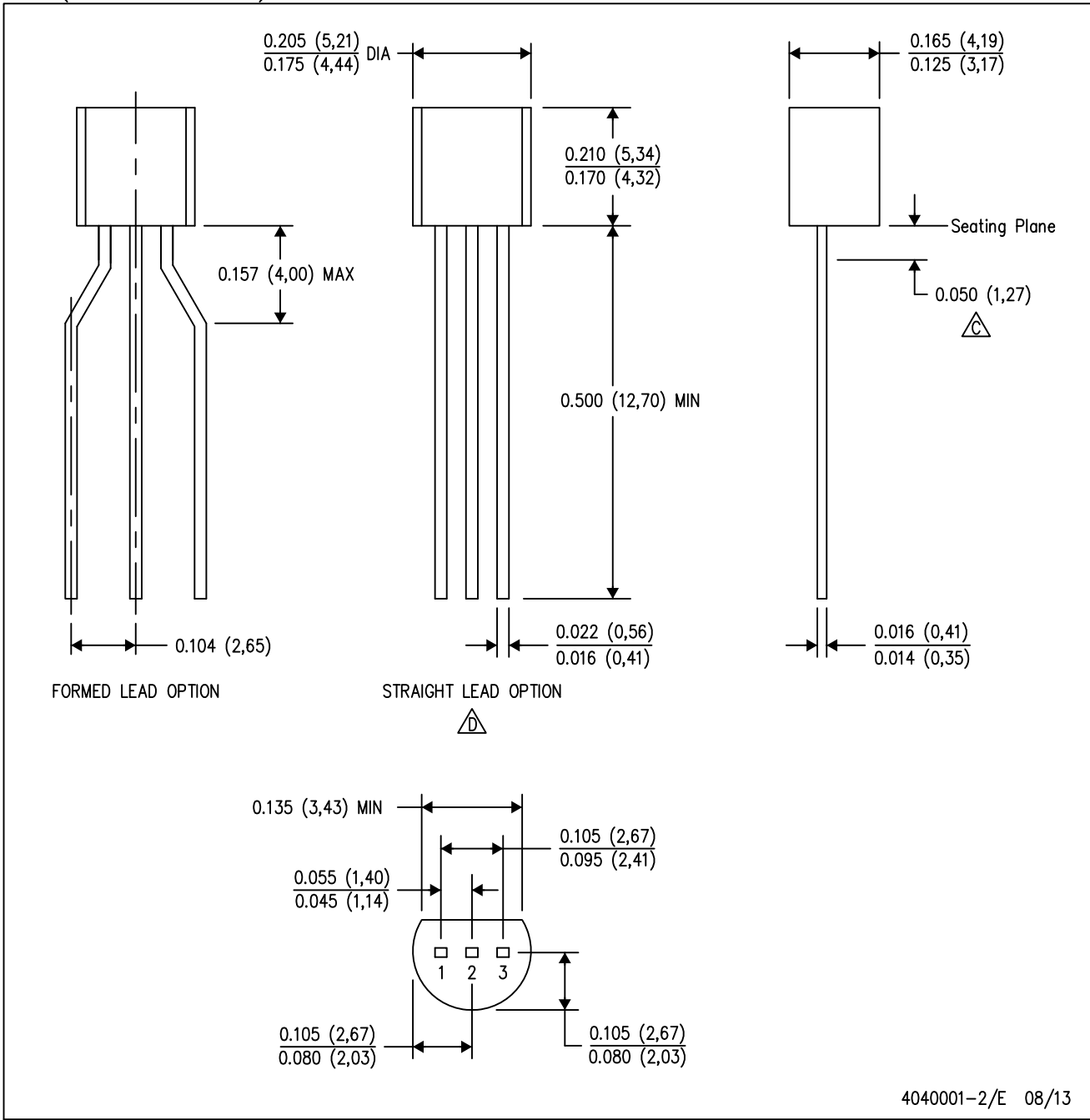
PLASTIC CYLINDRICAL PACKAGE



4040001-2/E 08/13

- NOTES:
- A. All linear dimensions are in inches (millimeters).
 - B. This drawing is subject to change without notice.
 -  Lead dimensions are not controlled within this area.
 -  Falls within JEDEC TO-226 Variation AA (TO-226 replaces TO-92).
 - E. Shipping Method:
 Straight lead option available in bulk pack only.
 Formed lead option available in tape & reel or ammo pack.
 Specific products can be offered in limited combinations of shipping mediums and lead options.
 Consult product folder for more information on available options.

MECHANICAL DATA

LP (O-PBCY-W3)

PLASTIC CYLINDRICAL PACKAGE

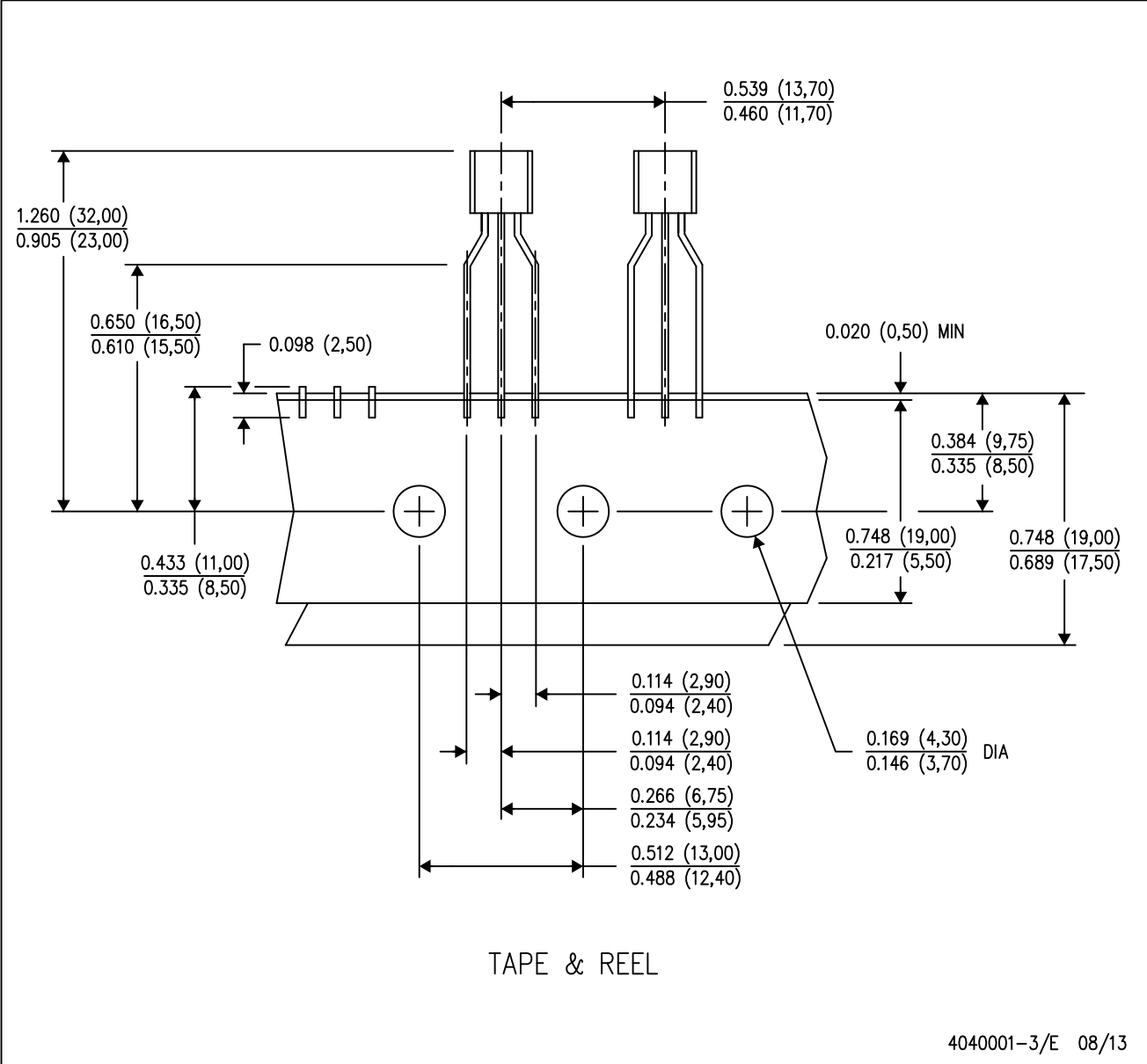

- NOTES:
- A. All linear dimensions are in inches (millimeters).
 - B. This drawing is subject to change without notice.
 - C. Tape and Reel information for the Formed Lead Option package.

IMPORTANT NOTICE

Texas Instruments Incorporated and its subsidiaries (TI) reserve the right to make corrections, enhancements, improvements and other changes to its semiconductor products and services per JESD46, latest issue, and to discontinue any product or service per JESD48, latest issue. Buyers should obtain the latest relevant information before placing orders and should verify that such information is current and complete. All semiconductor products (also referred to herein as "components") are sold subject to TI's terms and conditions of sale supplied at the time of order acknowledgment.

TI warrants performance of its components to the specifications applicable at the time of sale, in accordance with the warranty in TI's terms and conditions of sale of semiconductor products. Testing and other quality control techniques are used to the extent TI deems necessary to support this warranty. Except where mandated by applicable law, testing of all parameters of each component is not necessarily performed.

TI assumes no liability for applications assistance or the design of Buyers' products. Buyers are responsible for their products and applications using TI components. To minimize the risks associated with Buyers' products and applications, Buyers should provide adequate design and operating safeguards.

TI does not warrant or represent that any license, either express or implied, is granted under any patent right, copyright, mask work right, or other intellectual property right relating to any combination, machine, or process in which TI components or services are used. Information published by TI regarding third-party products or services does not constitute a license to use such products or services or a warranty or endorsement thereof. Use of such information may require a license from a third party under the patents or other intellectual property of the third party, or a license from TI under the patents or other intellectual property of TI.

Reproduction of significant portions of TI information in TI data books or data sheets is permissible only if reproduction is without alteration and is accompanied by all associated warranties, conditions, limitations, and notices. TI is not responsible or liable for such altered documentation. Information of third parties may be subject to additional restrictions.

Resale of TI components or services with statements different from or beyond the parameters stated by TI for that component or service voids all express and any implied warranties for the associated TI component or service and is an unfair and deceptive business practice. TI is not responsible or liable for any such statements.

Buyer acknowledges and agrees that it is solely responsible for compliance with all legal, regulatory and safety-related requirements concerning its products, and any use of TI components in its applications, notwithstanding any applications-related information or support that may be provided by TI. Buyer represents and agrees that it has all the necessary expertise to create and implement safeguards which anticipate dangerous consequences of failures, monitor failures and their consequences, lessen the likelihood of failures that might cause harm and take appropriate remedial actions. Buyer will fully indemnify TI and its representatives against any damages arising out of the use of any TI components in safety-critical applications.

In some cases, TI components may be promoted specifically to facilitate safety-related applications. With such components, TI's goal is to help enable customers to design and create their own end-product solutions that meet applicable functional safety standards and requirements. Nonetheless, such components are subject to these terms.

No TI components are authorized for use in FDA Class III (or similar life-critical medical equipment) unless authorized officers of the parties have executed a special agreement specifically governing such use.

Only those TI components which TI has specifically designated as military grade or "enhanced plastic" are designed and intended for use in military/aerospace applications or environments. Buyer acknowledges and agrees that any military or aerospace use of TI components which have **not** been so designated is solely at the Buyer's risk, and that Buyer is solely responsible for compliance with all legal and regulatory requirements in connection with such use.

TI has specifically designated certain components as meeting ISO/TS16949 requirements, mainly for automotive use. In any case of use of non-designated products, TI will not be responsible for any failure to meet ISO/TS16949.

Products

Audio	www.ti.com/audio
Amplifiers	amplifier.ti.com
Data Converters	dataconverter.ti.com
DLP® Products	www.dlp.com
DSP	dsp.ti.com
Clocks and Timers	www.ti.com/clocks
Interface	interface.ti.com
Logic	logic.ti.com
Power Mgmt	power.ti.com
Microcontrollers	microcontroller.ti.com
RFID	www.ti-rfid.com
OMAP Applications Processors	www.ti.com/omap
Wireless Connectivity	www.ti.com/wirelessconnectivity

Applications

Automotive and Transportation	www.ti.com/automotive
Communications and Telecom	www.ti.com/communications
Computers and Peripherals	www.ti.com/computers
Consumer Electronics	www.ti.com/consumer-apps
Energy and Lighting	www.ti.com/energy
Industrial	www.ti.com/industrial
Medical	www.ti.com/medical
Security	www.ti.com/security
Space, Avionics and Defense	www.ti.com/space-avionics-defense
Video and Imaging	www.ti.com/video

TI E2E Community

e2e.ti.com

Mouser Electronics

Authorized Distributor

Click to View Pricing, Inventory, Delivery & Lifecycle Information:

Texas Instruments:

[LM337LM](#) [LM337LM/NOPB](#) [LM337LMX](#) [LM337LMX/NOPB](#) [LM337LZ/LFT1](#) [LM337LZ/LFT3](#) [LM337LZ/NOPB](#)
[LM337LZ/LFT4](#)