

High frequency ultrafast diode

Datasheet - production data

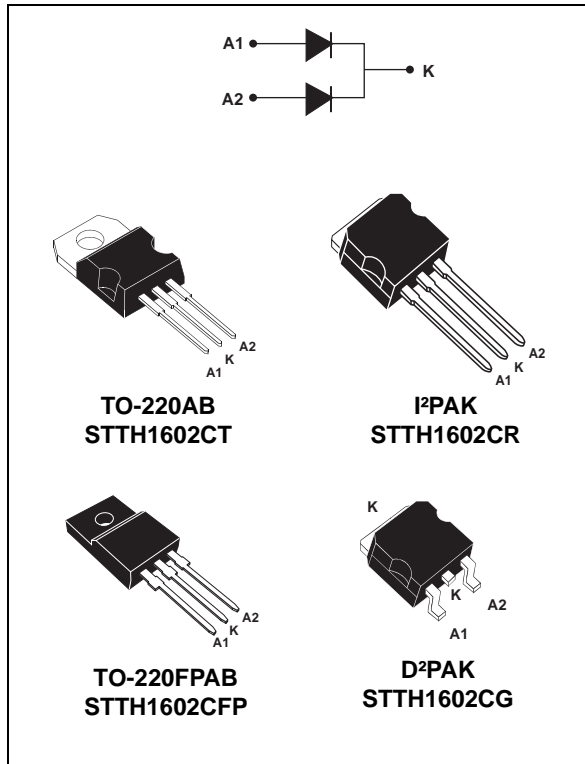

Description

Dual center tap rectifier suited for switch mode power supplies and high frequency DC to DC converters.

Packaged in TO-220AB, D²PAK, TO-220FPAB and I²PAK, this device is intended for use in low voltage, high frequency inverters, free wheeling and polarity protection applications.

Table 1. Device summary

Symbol	Value
$I_{F(AV)}$	Up to 2 x 10 A
V_{RRM}	200 V
T_j (max)	175 °C
V_F (typ)	0.78 V
t_{rr} (typ)	21 ns

Features

- Suited for SMPS
- Low losses
- Low forward and reverse recovery times
- Low leakage current
- High junction temperature
- Insulated package: TO-220FPAB

1 Characteristics

Table 2. Absolute ratings (limiting values, per diode)

Symbol	Parameter			Value	Unit	
V_{RRM}	Repetitive peak reverse voltage			200	V	
$I_{F(RMS)}$	RMS forward voltage			30	A	
$I_{F(peak)}$	Average forward current $\delta = 0.5$	$I^2PAK, D^2PAK, TO-220AB$	$T_c = 140\text{ }^\circ\text{C}$	Per diode	8	A
			$T_c = 140\text{ }^\circ\text{C}$	Per device	16	A
			$T_c = 140\text{ }^\circ\text{C}$	Per diode	10	A
			$T_c = 140\text{ }^\circ\text{C}$	Per device	20	A
		$TO-220FPAB$	$T_c = 140\text{ }^\circ\text{C}$	Per diode	8	A
			$T_c = 140\text{ }^\circ\text{C}$	Per device	16	A
			$T_c = 140\text{ }^\circ\text{C}$	Per diode	10	A
			$T_c = 140\text{ }^\circ\text{C}$	Per device	20	A
I_{FSM}	Surge non repetitive forward current	$t_p = 10\text{ ms sinusoidal}$		80	A	
T_{stg}	Storage temperature range			-65 to + 175	$^\circ\text{C}$	
T_j	Maximum operating junction temperature			175	$^\circ\text{C}$	

Table 3. Thermal resistance

Symbol	Parameter			Value (max)	Unit
$R_{th(j-c)}$	Junction to case	$I^2PAK, D^2PAK, TO-220AB$	Per diode	3.0	$^\circ\text{C/W}$
			Total	1.9	
		$TO-220FPAB$	Per diode	5.5	
			Total	4.5	
$R_{th(c)}$	Coupling	$I^2PAK, D^2PAK, TO-220AB$	Coupling	0.8	
		$TO-220FPAB$	Coupling	3.5	

Table 4. Static electrical characteristics (per diode)

Symbol	Parameter	Test conditions		Min.	Typ	Max.	Unit
$I_R^{(1)}$	Reverse leakage current	$T_j = 25\text{ °C}$	$V_R = V_{RRM}$			6	μA
		$T_j = 125\text{ °C}$			4	60	
$V_F^{(2)}$	Forward voltage drop	$T_j = 25\text{ °C}$	$I_F = 8\text{ A}$			1.1	V
		$T_j = 25\text{ °C}$	$I_F = 16\text{ A}$			1.25	
		$T_j = 150\text{ °C}$	$I_F = 8\text{ A}$		0.78	0.89	
		$T_j = 150\text{ °C}$	$I_F = 16\text{ A}$			1.05	

1. Pulse test: $t_p = 5\text{ ms}$, $\delta < 2\%$

2. Pulse test: $t_p = 380\text{ }\mu\text{s}$, $\delta < 2\%$

Note: To evaluate the conduction losses use the following equation: $P = 0.73 \times I_{F(AV)} + 0.020 I_{F2(RMS)}$

Table 5. Dynamic electrical characteristics

Symbol	Parameter	Test conditions		Min.	Typ	Max.	Unit
t_{rr}	Reverse recovery time	$T_j = 25\text{ °C}$	$I_F = 1\text{ A}$ $V_R = 30\text{ V}$ $di_F/dt = 100\text{ A}/\mu\text{s}$		21	26	ns
t_{fr}	Forward recovery time	$T_j = 25\text{ °C}$	$I_F = 8\text{ A}$ $di_F/dt = 100\text{ A}/\mu\text{s}$ $V_{FR} = 1.1 \times V_{Fmax}$			160	ns
V_{FP}	Forward recovery voltage	$T_j = 25\text{ °C}$	$I_F = 8\text{ A}$ $di_F/dt = 100\text{ A}/\mu\text{s}$		2.4		V
I_{RM}	Reverse recovery current	$T_j = 125\text{ °C}$	$I_F = 8\text{ A}$ $V_R = 160\text{ V}$ $di_F/dt = 200\text{ A}/\mu\text{s}$		6.8	8.8	A

Figure 1. Peak current versus duty cycle (per diode)

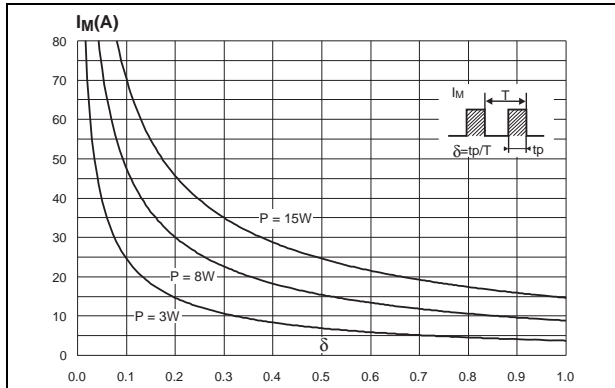

Figure 2. Forward voltage drop versus forward current (typical values, per diode)

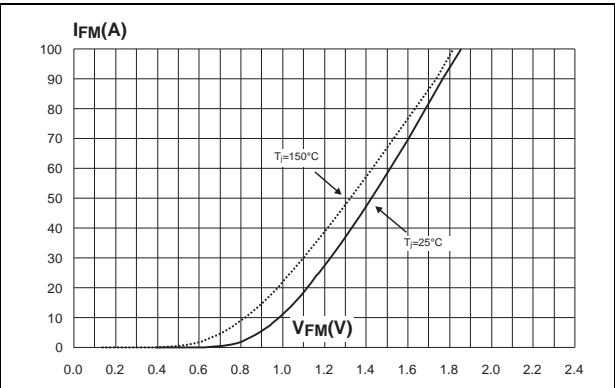

Figure 3. Forward voltage drop versus forward current (maximum values, per diode)

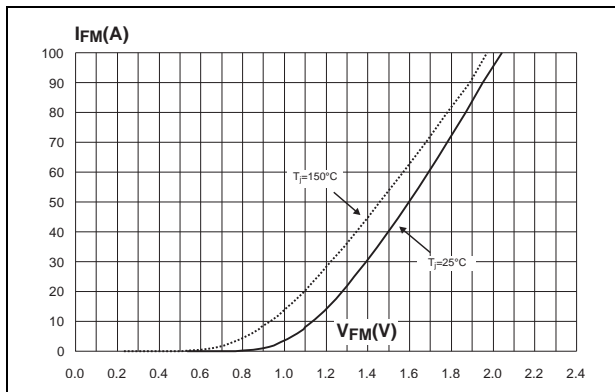

Figure 4. Relative variation of thermal impedance junction to case versus pulse duration (TO-220AB, D²PAK, I²PAK)

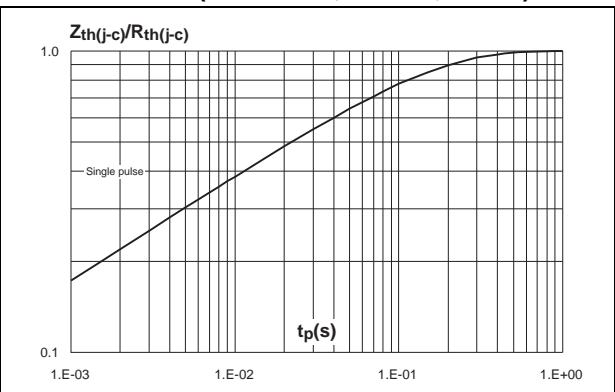

Figure 5. Relative variation of thermal impedance junction to case versus pulse duration (TO-220FPAB)

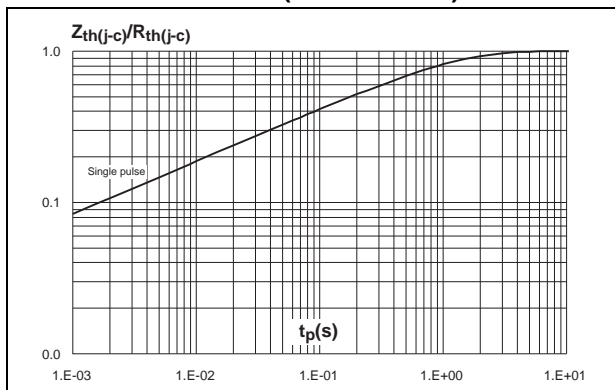

Figure 6. Junction capacitance versus reverse voltage applied (typical values, per diode)

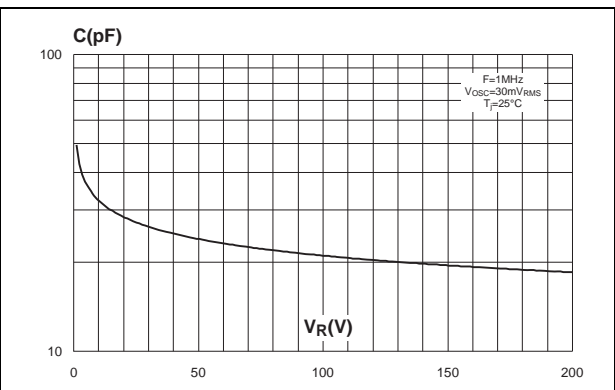

Figure 7. Reverse recovery charges versus di_F/dt (typical values, per diode)

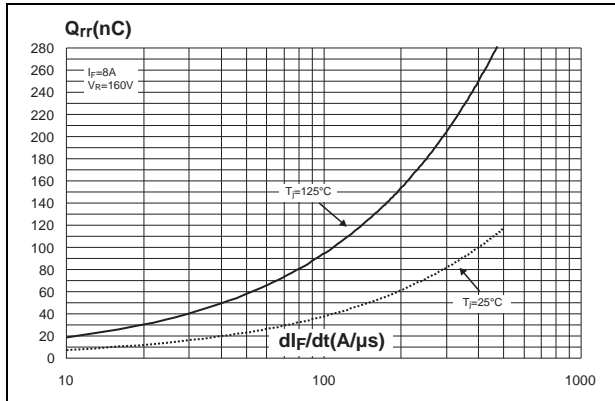

Figure 8. Reverse recovery time versus di_F/dt (typical values, per diode)

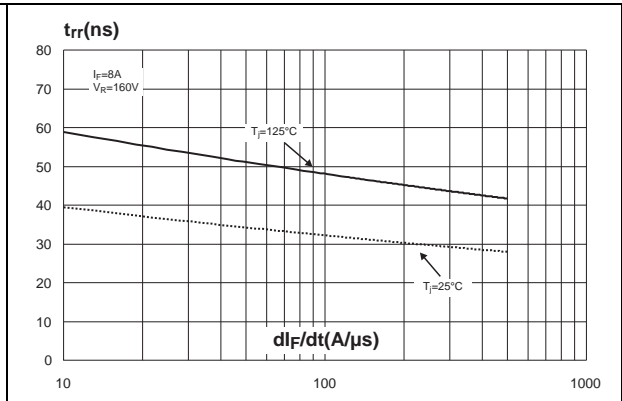

Figure 9. Peak reverse recovery current versus di_F/dt (typical values, per diode)

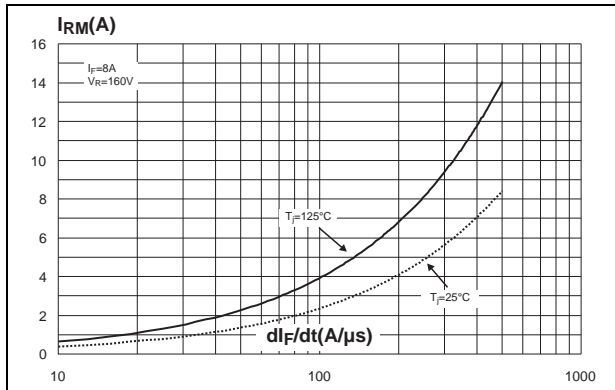

Figure 10. Dynamic parameters versus junction temperature

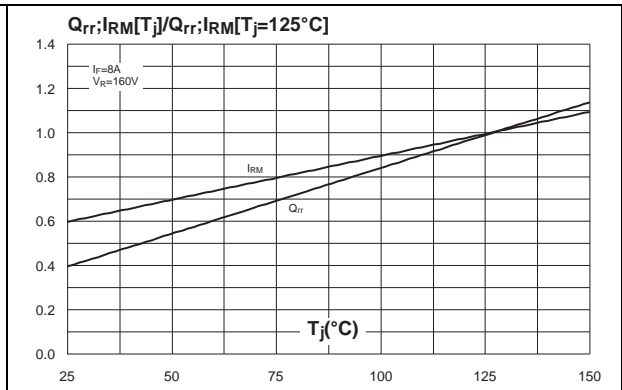
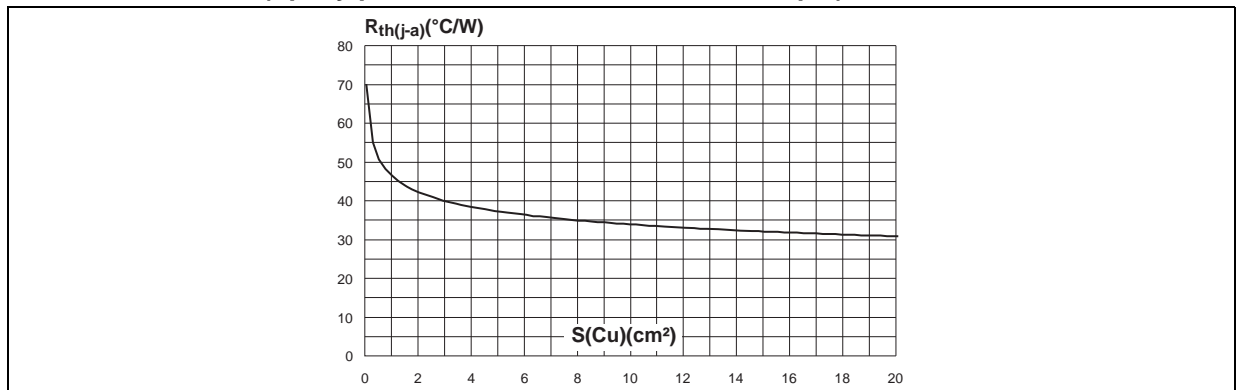

Figure 11. Thermal resistance junction to ambient versus copper surface under tab (Epoxy printed circuit board FR4, eCU: 35 μm) for D²PAK



2 Package mechanical data

- Epoxy meets UL94, V0
- Cooling method: by conduction (C)
- Recommended torque value(TO-220AB): 0.8 N·m
- Maximum torque value(TO-220AB): 1.0 N·m
- Recommended torque value(TO-220FPAB): 0.55 N·m
- Maximum torque value(TO-220FPAB): 0.7 N·m

In order to meet environmental requirements, ST (also) offers these devices in ECOPACK® packages. ECOPACK® packages are lead free. The category of second level interconnect is marked on the inner box label, in compliance with JEDEC Standard JESD97. The maximum ratings related to soldering conditions are also marked on the inner box label.

ECOPACK is an ST trademark. ECOPACK specifications are available at: www.st.com.

Table 6. I²PAK Package dimensions

Ref.	Dimensions			
	Millimeters		Inches	
	Min.	Max.	Min.	Max.
A	4.40	4.60	0.173	0.181
A1	2.40	2.72	0.094	0.107
b	0.61	0.88	0.024	0.035
b1	1.14	1.70	0.044	0.067
c	0.49	0.70	0.019	0.028
c2	1.23	1.32	0.048	0.052
D	8.95	9.35	0.352	0.368
e	2.40	2.70	0.094	0.106
e1	4.95	5.15	0.195	0.203
E	10	10.40	0.394	0.409
L	13	14	0.512	0.551
L1	3.50	3.93	0.138	0.155
L2	1.27	1.40	0.050	0.055

Figure 12. D²PAK dimension definitions

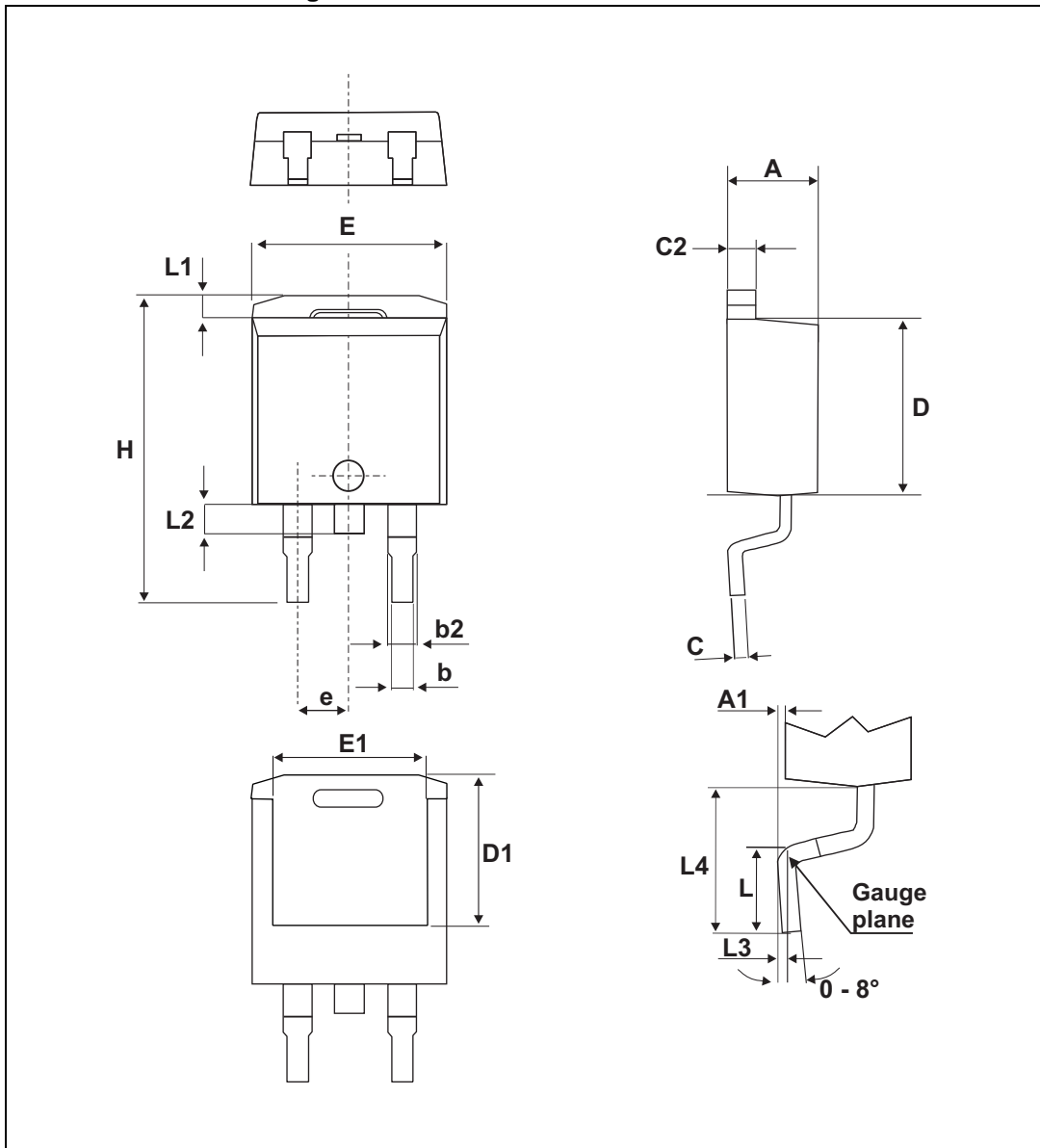

Table 7. D²PAK dimension values

Ref.	Dimensions			
	Millimeters		Inches	
	Min.	Max.	Min.	Max.
A	4.36	4.60	0.172	0.181
A1	0.00	0.25	0.000	0.010
b	0.70	0.93	0.028	0.037
b2	1.14	1.70	0.045	0.067
c	0.38	0.694	0.015	0.027
c1	0.38	0.534	0.015	0.021
c2	1.19	1.36	0.047	0.053
D	8.60	9.35	0.339	0.368
D1	6.90	-	0.272	-
E	10.00	10.55	0.394	0.415
E1	8.10	-	0.319	-
e	2.54 typ.		0.100 typ.	
H	15.00	15.85	0.591	0.624
L	1.90	2.79	0.075	0.110
L1	-	1.65	-	0.065
L2	-	1.78	-	0.070
L3	0.25 typ.		0.010 typ.	
L4	4.78	5.28	0.188	0.208

Figure 13. D²PAK footprint dimensions (in mm)

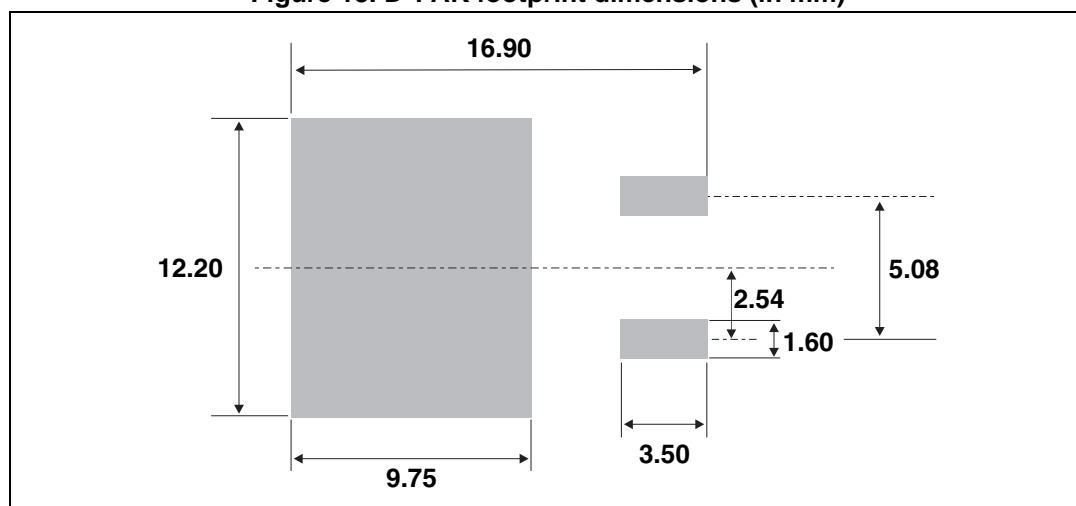
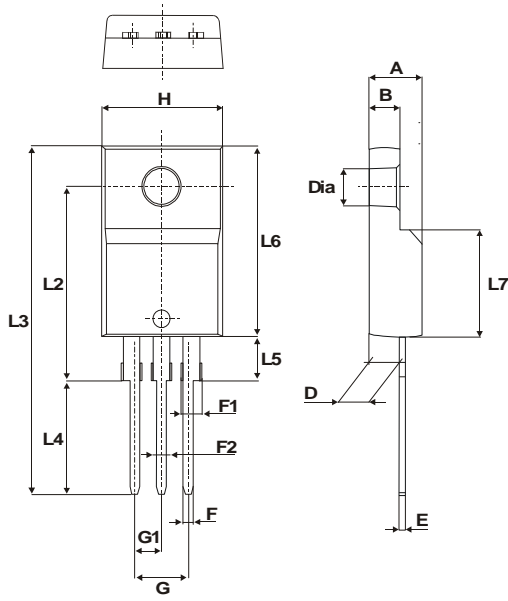

Table 8. TO-220AB Package dimensions

Ref.	Dimensions			
	Millimeters		Inches	
	Min.	Max.	Min.	Max.
A	4.40	4.60	0.173	0.181
C	1.23	1.32	0.048	0.051
D	2.40	2.72	0.094	0.107
E	0.49	0.70	0.019	0.027
F	0.61	0.88	0.024	0.034
F1	1.14	1.70	0.044	0.066
F2	1.14	1.70	0.044	0.066
G	4.95	5.15	0.194	0.202
G1	2.40	2.70	0.094	0.106
H2	10	10.40	0.393	0.409
L2	16.4 typ.		0.645 typ.	
L4	13	14	0.511	0.551
L5	2.65	2.95	0.104	0.116
L6	15.25	15.75	0.600	0.620
L7	6.20	6.60	0.244	0.259
L9	3.50	3.93	0.137	0.154
M	2.6 typ.		0.102 typ.	
Diam.	3.75	3.85	0.147	0.151

Table 9. TO-220FPAB Package dimensions

Ref.	Dimensions			
	Millimeters		Inches	
	Min.	Max.	Min.	Max.
A	4.4	4.6	0.173	0.181
B	2.5	2.7	0.098	0.106
D	2.5	2.75	0.098	0.108
E	0.45	0.70	0.018	0.027
F	0.75	1	0.030	0.039
F1	1.15	1.70	0.045	0.067
F2	1.15	1.70	0.045	0.067
G	4.95	5.20	0.195	0.205
G1	2.4	2.7	0.094	0.106
H	10	10.4	0.393	0.409
L2	16 Typ.		0.63 Typ.	
L3	28.6	30.6	1.126	1.205
L4	9.8	10.6	0.386	0.417
L5	2.9	3.6	0.114	0.142
L6	15.9	16.4	0.626	0.646
L7	9.00	9.30	0.354	0.366
Dia.	3.00	3.20	0.118	0.126



3 Ordering information

Table 10. Ordering information

Order code	Marking	Package	Weight	Base qty	Delivery mode
STTH1602CT	STTH1602CT	TO-220AB	2.23 g	50	Tube
STTH1602CG	STTH1602CG	D ² PAK	1.48 g	50	Tube
STTH1602CG-TR	STTH1602CG	D ² PAK	1.48 g	1000	Tape and reel
STTH1602CR	STTH1602CR	I ² PAK	1.49 g	50	Tube
STTH1602CFP	STTH1602CFP	TO-220AB	1.70 g	50	Tube

4 Revision history

Table 11. Document revision history

Date	Revision	Changes
Feb-2004	1	First issue.
23-Apr-2014	2	Updated ECOPACK statement. Reformatted to current standards. Updated Section 2: Package mechanical data

Please Read Carefully:

Information in this document is provided solely in connection with ST products. STMicroelectronics NV and its subsidiaries ("ST") reserve the right to make changes, corrections, modifications or improvements, to this document, and the products and services described herein at any time, without notice.

All ST products are sold pursuant to ST's terms and conditions of sale.

Purchasers are solely responsible for the choice, selection and use of the ST products and services described herein, and ST assumes no liability whatsoever relating to the choice, selection or use of the ST products and services described herein.

No license, express or implied, by estoppel or otherwise, to any intellectual property rights is granted under this document. If any part of this document refers to any third party products or services it shall not be deemed a license grant by ST for the use of such third party products or services, or any intellectual property contained therein or considered as a warranty covering the use in any manner whatsoever of such third party products or services or any intellectual property contained therein.

UNLESS OTHERWISE SET FORTH IN ST'S TERMS AND CONDITIONS OF SALE ST DISCLAIMS ANY EXPRESS OR IMPLIED WARRANTY WITH RESPECT TO THE USE AND/OR SALE OF ST PRODUCTS INCLUDING WITHOUT LIMITATION IMPLIED WARRANTIES OF MERCHANTABILITY, FITNESS FOR A PARTICULAR PURPOSE (AND THEIR EQUIVALENTS UNDER THE LAWS OF ANY JURISDICTION), OR INFRINGEMENT OF ANY PATENT, COPYRIGHT OR OTHER INTELLECTUAL PROPERTY RIGHT.

ST PRODUCTS ARE NOT DESIGNED OR AUTHORIZED FOR USE IN: (A) SAFETY CRITICAL APPLICATIONS SUCH AS LIFE SUPPORTING, ACTIVE IMPLANTED DEVICES OR SYSTEMS WITH PRODUCT FUNCTIONAL SAFETY REQUIREMENTS; (B) AERONAUTIC APPLICATIONS; (C) AUTOMOTIVE APPLICATIONS OR ENVIRONMENTS, AND/OR (D) AEROSPACE APPLICATIONS OR ENVIRONMENTS. WHERE ST PRODUCTS ARE NOT DESIGNED FOR SUCH USE, THE PURCHASER SHALL USE PRODUCTS AT PURCHASER'S SOLE RISK, EVEN IF ST HAS BEEN INFORMED IN WRITING OF SUCH USAGE, UNLESS A PRODUCT IS EXPRESSLY DESIGNATED BY ST AS BEING INTENDED FOR "AUTOMOTIVE, AUTOMOTIVE SAFETY OR MEDICAL" INDUSTRY DOMAINS ACCORDING TO ST PRODUCT DESIGN SPECIFICATIONS. PRODUCTS FORMALLY ESCC, QML OR JAN QUALIFIED ARE DEEMED SUITABLE FOR USE IN AEROSPACE BY THE CORRESPONDING GOVERNMENTAL AGENCY.

Resale of ST products with provisions different from the statements and/or technical features set forth in this document shall immediately void any warranty granted by ST for the ST product or service described herein and shall not create or extend in any manner whatsoever, any liability of ST.

ST and the ST logo are trademarks or registered trademarks of ST in various countries.

Information in this document supersedes and replaces all information previously supplied.

The ST logo is a registered trademark of STMicroelectronics. All other names are the property of their respective owners.

© 2014 STMicroelectronics - All rights reserved

STMicroelectronics group of companies

Australia - Belgium - Brazil - Canada - China - Czech Republic - Finland - France - Germany - Hong Kong - India - Israel - Italy - Japan - Malaysia - Malta - Morocco - Philippines - Singapore - Spain - Sweden - Switzerland - United Kingdom - United States of America

www.st.com

Mouser Electronics

Authorized Distributor

Click to View Pricing, Inventory, Delivery & Lifecycle Information:

[STMicroelectronics:](#)

[STTH1602CT](#) [STTH1602CFP](#) [STTH1602CG-TR](#)