



P-Channel Logic Level Enhancement Mode Field Effect Transistor

PRODUCT SUMMARY

VDSS	ID	RDS(ON) (mΩ) Max
-60V	-15A	95 @ VGS=-10V
		125 @ VGS=-4.5V

FEATURES

- Super high dense cell design for low $R_{DS(ON)}$.
- Rugged and reliable.
- Surface Mount Package.
- ESD Protected.



STU SERIES
TO-252AA(D-PAK)

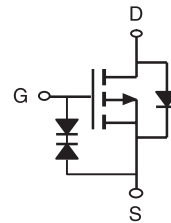

ABSOLUTE MAXIMUM RATINGS ($T_C=25^\circ\text{C}$ unless otherwise noted)

Symbol	Parameter	Limit	Units
V_{DS}	Drain-Source Voltage	-60	V
V_{GS}	Gate-Source Voltage	± 20	V
I_D	Drain Current-Continuous ^a	$T_C=25^\circ\text{C}$	-15
		$T_C=70^\circ\text{C}$	-12
I_{DM}	-Pulsed ^b	-45	A
E_{AS}	Single Pulse Avalanche Energy ^d	36	mJ
P_D	Maximum Power Dissipation ^a	$T_C=25^\circ\text{C}$	42
		$T_C=70^\circ\text{C}$	27
T_J, T_{STG}	Operating Junction and Storage Temperature Range	-55 to 150	$^\circ\text{C}$

THERMAL CHARACTERISTICS

$R_{\theta JC}$	Thermal Resistance, Junction-to-Case ^a	3	$^\circ\text{C/W}$
$R_{\theta JA}$	Thermal Resistance, Junction-to-Ambient ^a	50	$^\circ\text{C/W}$

STU601S

Ver 2.0

ELECTRICAL CHARACTERISTICS (T_C=25°C unless otherwise noted)

Symbol	Parameter	Conditions	Min	Typ	Max	Units
OFF CHARACTERISTICS						
BV _{DSS}	Drain-Source Breakdown Voltage	V _{GS} =0V , I _D =-250uA	-60			V
I _{DSS}	Zero Gate Voltage Drain Current	V _{DS} =-48V , V _{GS} =0V			1	uA
I _{GSS}	Gate-Body Leakage Current	V _{GS} = ±20V , V _{DS} =0V			±10	uA
ON CHARACTERISTICS						
V _{GS(th)}	Gate Threshold Voltage	V _{DS} =V _{GS} , I _D =-250uA	-1	-2.3	-3	V
R _{DS(ON)}	Drain-Source On-State Resistance	V _{GS} =-10V , I _D =-7.5A		78	95	m ohm
		V _{GS} =-4.5V , I _D =-6.5A		93	125	m ohm
g _{FS}	Forward Transconductance	V _{DS} =-10V , I _D =-7.5A		17		S
DYNAMIC CHARACTERISTICS °						
C _{ISS}	Input Capacitance	V _{DS} =-25V, V _{GS} =0V f=1.0MHz		1107		pF
C _{OSS}	Output Capacitance			76		pF
C _{RSS}	Reverse Transfer Capacitance			56		pF
SWITCHING CHARACTERISTICS °						
t _{D(ON)}	Turn-On Delay Time	V _{DD} =-30V I _D =-1.0A V _{GS} =-10V R _{GEN} = 6 ohm		21.4		ns
t _r	Rise Time			19		ns
t _{D(OFF)}	Turn-Off Delay Time			92.2		ns
t _f	Fall Time			13.3		ns
Q _g	Total Gate Charge	V _{DS} =-30V, I _D =-7.5A, V _{GS} =-10V		23		nC
		V _{DS} =-30V, I _D =-7.5A, V _{GS} =-4.5V		10.6		nC
Q _{gs}	Gate-Source Charge	V _{DS} =-30V, I _D =-7.5A, V _{GS} =-10V		2.9		nC
Q _{gd}	Gate-Drain Charge			5.9		nC
DRAIN-SOURCE DIODE CHARACTERISTICS						
V _{SD}	Diode Forward Voltage	V _{GS} =0V, I _S = -2A		-0.82	-1.3	V

Notes

- Surface Mounted on FR4 Board, t ≤ 10sec.
- Pulse Test: Pulse Width ≤ 300us, Duty Cycle ≤ 2%.
- Guaranteed by design, not subject to production testing.
- Starting T_J=25°C, L=0.5mH, V_{DD} = 30V .(See Figure13)

Nov,16,2011

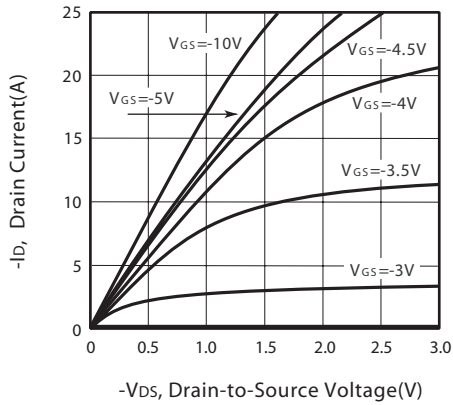

Figure 1. Output Characteristics

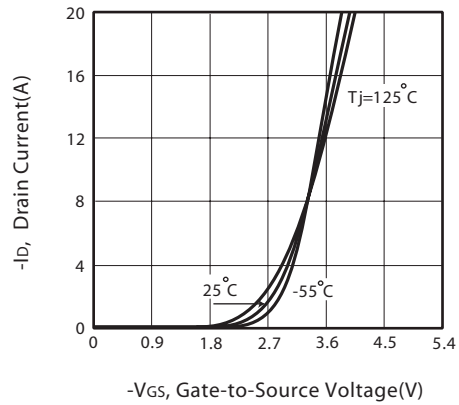

Figure 2. Transfer Characteristics

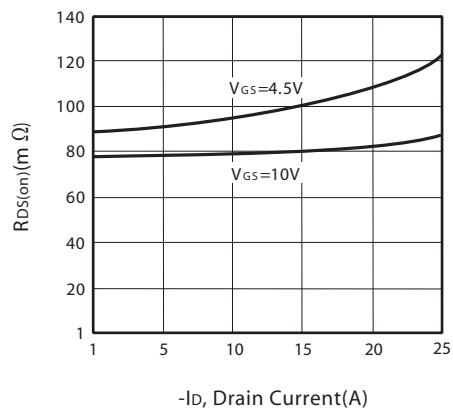

Figure 3. On-Resistance vs. Drain Current and Gate Voltage

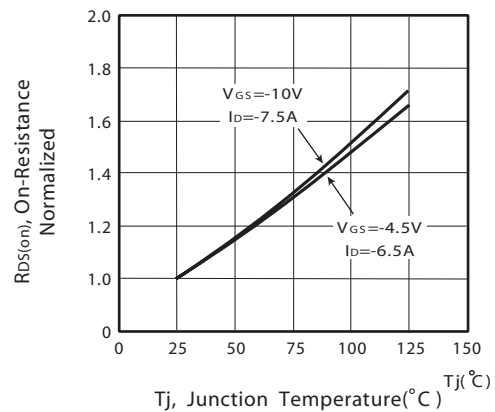

Figure 4. On-Resistance Variation with Drain Current and Temperature

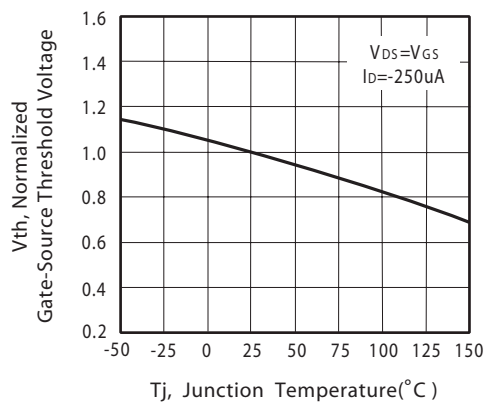

Figure 5. Gate Threshold Variation with Temperature

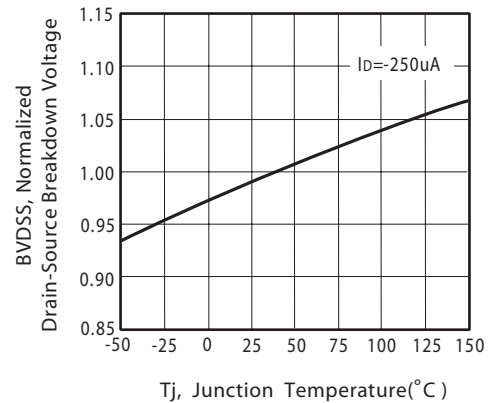

Figure 6. Breakdown Voltage Variation with Temperature

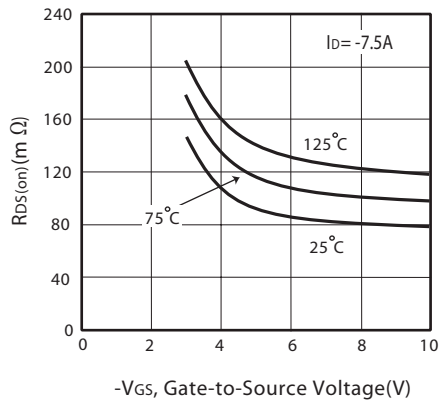

Figure 7. On-Resistance vs. Gate-Source Voltage

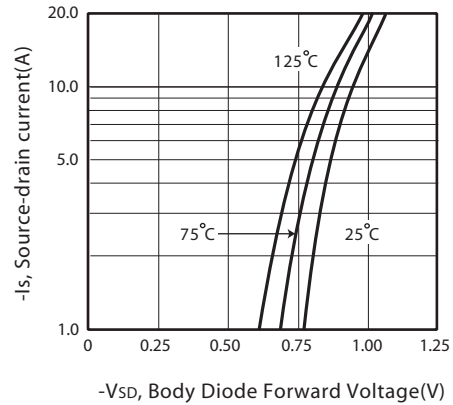

Figure 8. Body Diode Forward Voltage Variation with Source Current

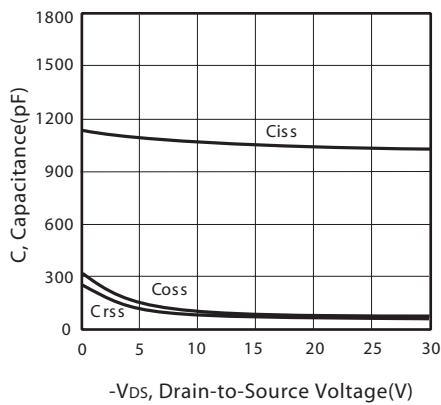

Figure 9. Capacitance

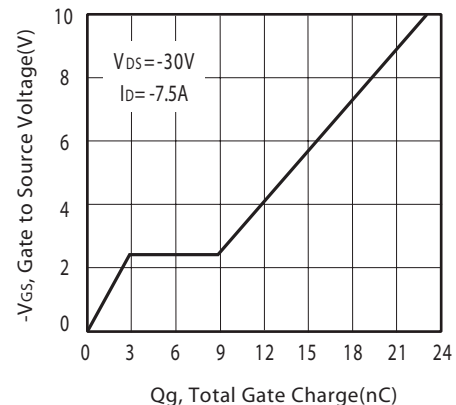

Figure 10. Gate Charge

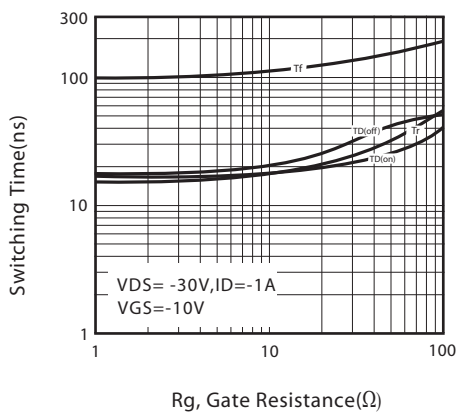

Figure 11. switching characteristics

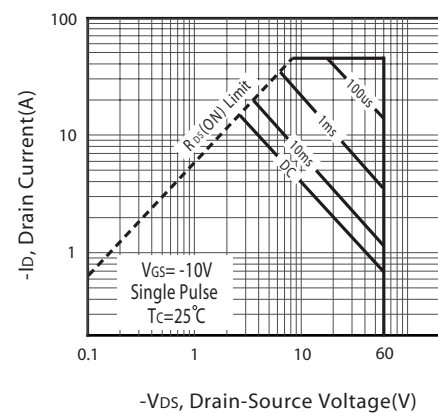
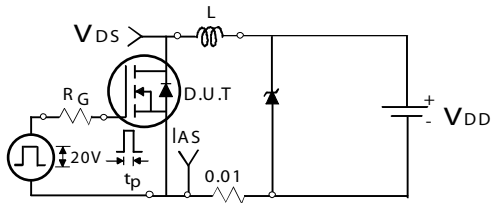
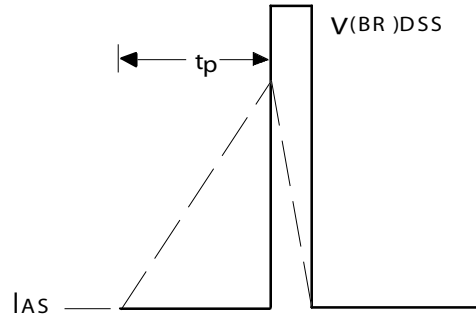

Figure 12. Maximum Safe Operating Area



Unclamped Inductive Test Circuit

Figure 13a.



Unclamped Inductive Waveforms

Figure 13b.

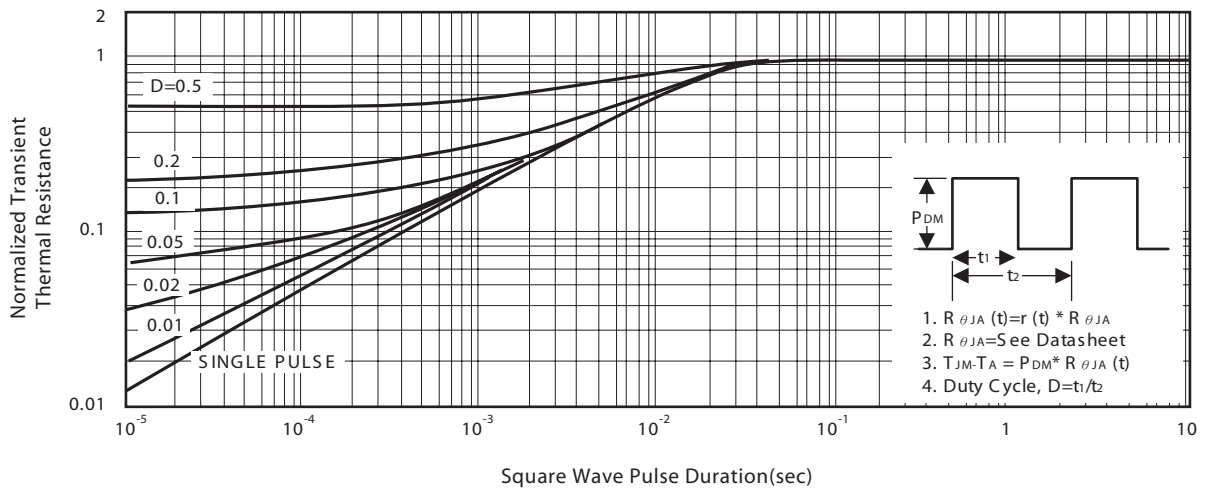
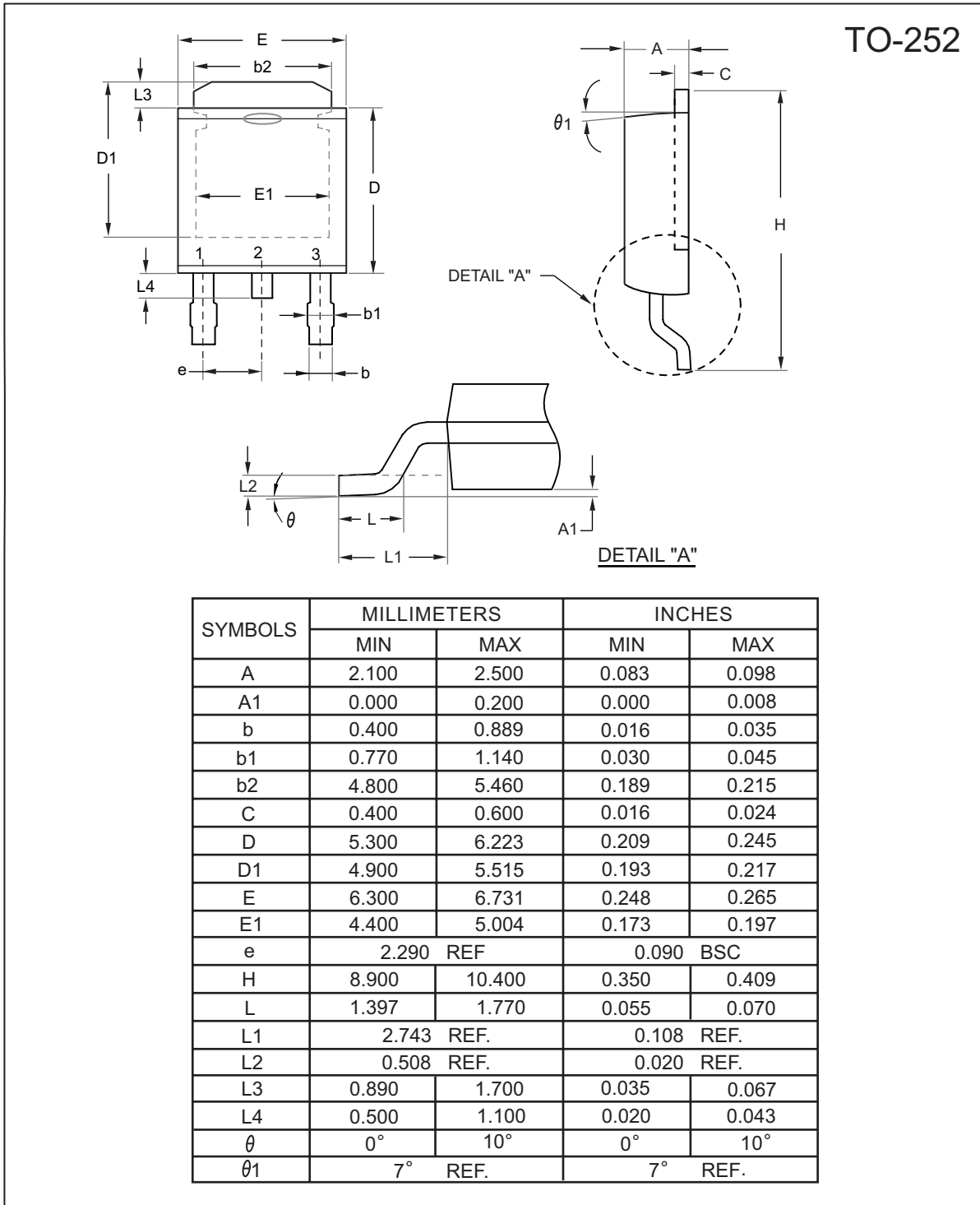

Figure 14. Normalized Thermal Transient Impedance Curve

STU601S

Ver 2.0



Nov,16,2011

TO-252 Tape and Reel Data

TO-252 Carrier Tape

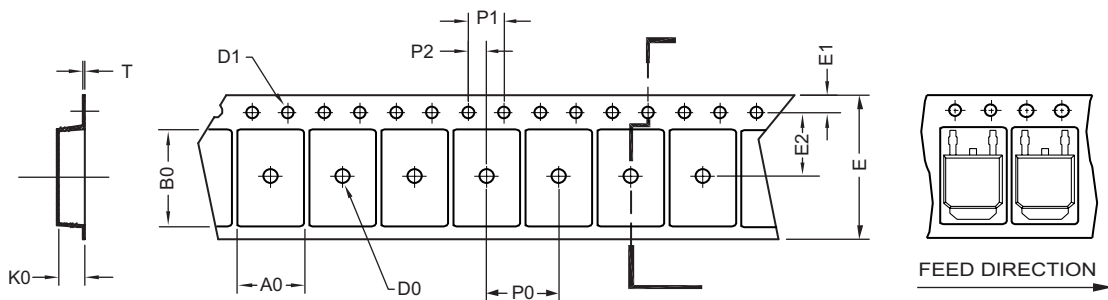

UNIT:mm

PACKAGE	A0	B0	K0	D0	D1	E	E1	E2	P0	P1	P2	T
TO-252 (16 mm)	6.96 ±0.1	10.49 ±0.1	2.79 ±0.1	φ2	φ1.5 +0.1 -0	16.0 ±0.3	1.75 ±0.1	7.5 ±0.15	8.0 ±0.1	4.0 ±0.1	2.0 ±0.15	0.3 ±0.05

TO-252 Reel

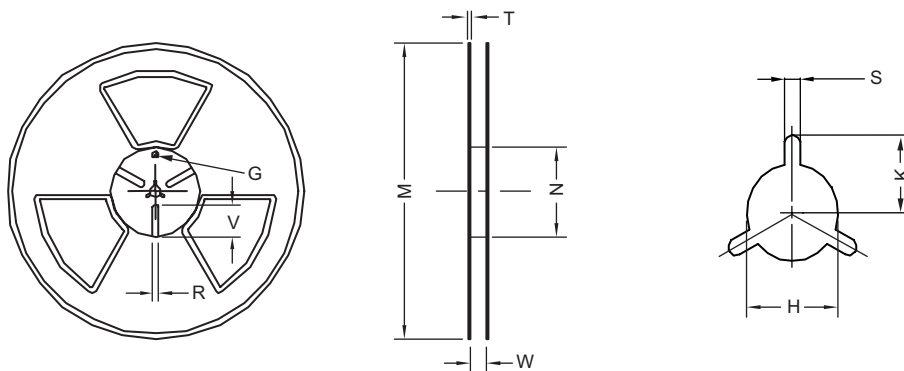

UNIT:mm

TAPE SIZE	REEL SIZE	M	N	W	T	H	K	S	G	R	V
16 mm	φ 330	φ 330 ± 0.5	φ 97 ± 1.0	17.0 + 1.5 - 0	2.2	φ 13.0 + 0.5 - 0.2	10.6	2.0 ±0.5	---	---	---